

# LH0024 and LH0032 High Speed Op Amp Applications

National Semiconductor  
Application Note 253  
January 1982



LH0024 and LH0032 High Speed Op Amp Applications

AN-253

## INTRODUCTION

The LH0024 and LH0032 are very high speed general purpose operational amplifiers exhibiting 70 MHz bandwidths, 500 V/μs slew rates and 100 to 300 ns settling time to 0.1%. The LH0032 has the added advantage of FET input characteristics. Both, however, can drive loads with peak currents of 100 milliamperes (mA). The op amps are stable without external compensation when operating at closed-loop gains of more than 100. Both are constructed with thick film hybrid technology and are actively trimmed for consistent device performance. Table 1 summarizes the typical performance data for these op amps. Additional information may be obtained from the respective data sheets.

This note is divided into three parts, with the first giving a general description of the circuit topology of each op amp. In the following section, several high performance applications are discussed. Finally, the last section consolidates all application techniques into an integral design approach, much of which is applicable to any high frequency circuit.

## LH0024 CIRCUIT DESCRIPTION

The LH0024 contains two gain stages: One is a differential NPN pair and the other is a single-ended PNP stage. The complete schematic is shown in Figure 1.

The input stage differential pair, Q8 and Q9, is biased at 6 mA by a current source made up of Q1, Q2, R3, and R5. First stage differential voltage gain is typically 2. Its output is applied differentially from base to emitter of the second stage transistor Q3 which has a gain of about 1,700. This stage also converts the differential signal to a single-ended output.

Current source Q5 and R4 provide 5 mA of DC bias current and a high impedance load to Q3. Overall amplifier gain is the product of the gains of the two stages— $2 \times 1700 = 3,400$ , or 71 dB.

The output complementary pair with class B bias provides a low impedance sourcing and sinking output drive. Although the class B bias contributes a small amount of cross-over distortion, it is barely detectable in closed loop operation.

## LH0032 CIRCUIT DESCRIPTION

The LH0032 is a general purpose operational amplifier similar to the LH0024, but with JFET input devices instead of bipolar. As a result, the LH0032 DC input bias and offset currents are three orders of magnitude lower than the LH0024. Its output drive capability is improved due to the use of a larger package with lower thermal resistance, and its class AB output, which is normally biased on, virtually eliminates cross-over distortion.

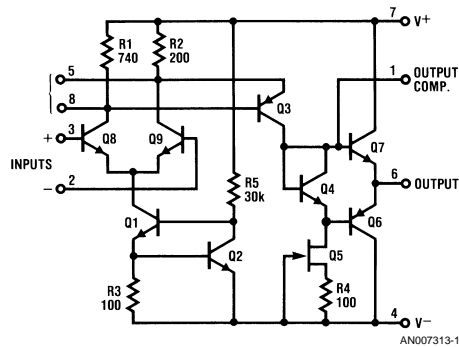

FIGURE 1. Complete LH0024 Schematic Diagram

TABLE 1. Typical Performance Characteristics

Parameter (T <sub>A</sub> = 25°C)	Conditions	LH0024	LH0032	Units
Input Offset Voltage		2	2	mV
Input Bias Current		15 μA	10 pA	
Large Signal Voltage Gain	V <sub>OUT</sub> = ±10V f = 1 kHz, R <sub>L</sub> = 1 kΩ	71	70	dB
Slew Rate	A <sub>V</sub> = +1, ΔV <sub>IN</sub> = 20V	500	500	V/μs
Small Signal Rise Time	A <sub>V</sub> = +1, ΔV <sub>IN</sub> = 1V	8	8	ns
Settling Time to 1.0% of Final Value	A <sub>V</sub> = -1, ΔV <sub>IN</sub> = 20V	80	100	ns
Settling Time to 0.1% of Final Value		275	300	ns
Unity Gain Bandwidth	(uncompensated)	70	70	Mhz

The improved DC performance is due, in part, to the incorporation of monolithic dual junction FETs in the input stage of the LH0032, providing matched DC tracking and good common-mode input characteristics. First stage operating current is set at 6 mA by the current source made up of transistors Q8 and Q9 and resistors R4 and R9, as shown in Figure 2. The first stage voltage gain is:

$$A_V (1st\ stage) = g_m R_L = 1.4 \quad (1)$$

Where:  $g_m = 3.5\text{ mmho}$

$$R_L = R_1 \parallel (\beta_3 + 1)(r_{e3} + 2R_3)$$

The second stage consists of two identical pairs of differential PNP transistors in a cascode configuration. Each side operates at 5 mA set by the emitter resistor R3 and the bias

AN-253

of the first stage. The differential amplifier Q3 and Q4 feeds the common-base pair Q5 and Q6 with the base voltage fixed at  $V^+ - 1.9$  volts by the diode string Q13–A15. Thus the collectors of the differential pair Q3 and Q4 are held at one  $V_{BE}$  drop more positive than the reference voltage. Any signal amplified by the differential stage produces only a very small change in Q3 and Q4 collector voltage. Consequently, the Miller effect on Q3 and Q4 (base-to-collector capacitances) is virtually eliminated. Using hybrid  $\pi$  model of the transistor, the voltage gain of the cascode stage may be approximated as:

$$A_V \text{ (2nd stage)} = g_{m4} \times R_{eq} \approx 1,400 \quad (2)$$

$$\text{Where: } g_{m4} = \frac{5 \text{ mA}}{0.026 \text{ V}}$$

$$R_{eq} = \frac{1}{h_{ob6}} \parallel \frac{1}{h_{oe10}} \parallel (\beta_{11} + 1) (R_L)$$

Notice that the full differential gain is realized with the use of the current mirror Q10 and Q16, which also provides high active load resistance to the PNP cascoded pair, resulting in high amplifier gain.

The collector output of the cascode stage is buffered by a pair of complementary emitter follower transistors, Q11 and Q12. This class AB output stage is normally biased at 1 mA by the 1.8  $V_{BE}$  voltage produced by Q7, R5, and R6. The emitter degeneration resistors provide protection from thermal runaway.

#### APPLICATIONS OF THE LH0024/LH0032

Applications of the high speed LH0024 and LH0032 range from video amplifiers to sampling circuits. The applications described below include high speed sample and hold circuits, photo-detector amplifiers, fast settling digital to analog converters, fast settling digital to analog converters and buffered amplifiers.

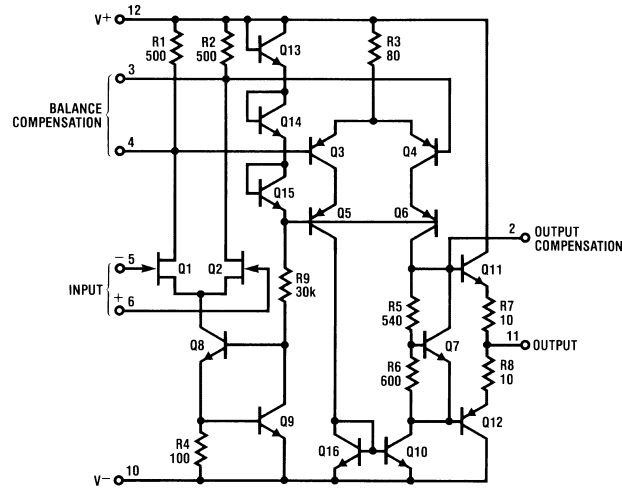

AN007313-2

FIGURE 2. Complete LH0032 Schematic Diagram

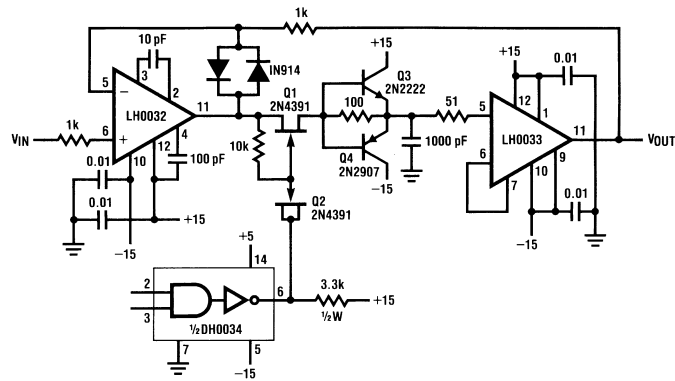

AN007313-3

FIGURE 3. High Speed Sample and Hold Circuit

### A High Speed S/H Circuit

High Speed sample-and-hold circuits require high slew rate and fast settling amplifiers. The LH0032 is ideal for these applications. An example is shown in Figure 3.

The complementary emitter-follower Q3 and Q4 sources or sinks large peak current to rapidly charge or discharge the hold capacitor during step changes, thus effectively buffering the FET switch, Q1, whose  $t_{D(ON)}$  would otherwise slow the charge time. The LH0033 FET-input amplifier buffers the output signal, providing 100 mA drive capability.

The circuit exhibits a 10V acquisition time of 900 ns to 0.1% accuracy and a droop rate of only 100  $\mu\text{V}/\text{ms}$  at 25°C ambient condition. An even faster acquisition time can be obtained using a smaller value hold-capacitor. By decreasing the value from 1000 pF to 220 pF, the acquisition time improves to 500 ns for a 10V step. However, droop rate increases to 500  $\mu\text{V}/\text{ms}$ .

### Fiber Optic Transmitter-Receiver Applications

Many fiber optic applications require analog drivers and receivers operating in the megahertz region where many so-called wide-band op amps simply run out of steam. Packed with 70 MHz gain-bandwidth product (unity gain compensated), the LH0032 is quite suitable for optical communication applications up to 3.5 MHz. Figure 4 demonstrates a complete analog transmission system using this device.

The transmitter incorporates the LF356 to drive the light emitter. The LED is normally biased at 50 mA operating current. The input is capacitively coupled and ranges from 0V to

5V, modulating the LED current from 0 mA to 100 mA. The circuit can be easily modified to operate from a single +15V power supply. The only requirement is that the amplifier must be biased within the input common mode range.

The receiver circuit uses an LH0032 configured as a transimpedance amplifier. A photodiode with 0.5 amp per watt responsivity such as the Hewlett-Packard type HP5082-4220, generates 50 mV signal at the receiver output for 1  $\mu\text{W}$  of light input.

Expectedly, the bandwidth of the entire optical link rests on the receiver circuit. Therefore, if the response time is to be optimized, one should reverse bias the photodiode to minimize junction capacitance. As a result, rise time improves more than 2 orders of magnitude. Next, the feedback resistor value should be chosen to be as large as possible in order to maximize sensitivity within the limits of allowable bandwidth degradation. Using 100 k $\Omega$  feedback resistor, the maximum system bandwidth is 3.5 MHz.

### Fast Settling 12-BIT D/A Converter

A high resolution, fast-settling DAC can be constructed using the LH0032. Its low input bias current causes no significant DC error in conversion accuracy. Great care must be exercised in circuit layout to assure highest performance. A single point analog ground should be used with the digital ground separated. A complete circuit with 12-bit resolution is shown in Figure 5. The converter typically settles to 1/2 LSB in 800 ns for a 10V full-scale swing. Similarly, 10-bit or 8-bit resolution DACs may be constructed using the DAC1020 or DAC0808, respectively.

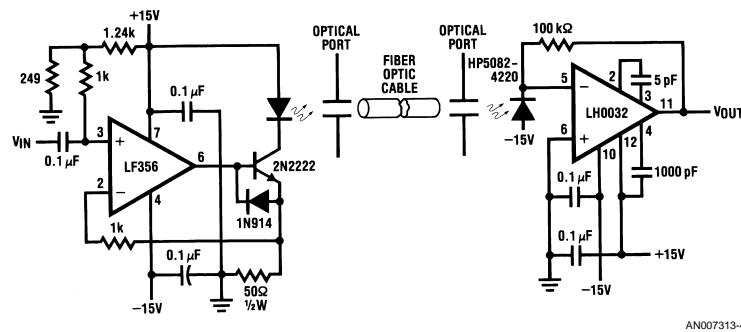

FIGURE 4. Fiber Optic Link

AN007313-4

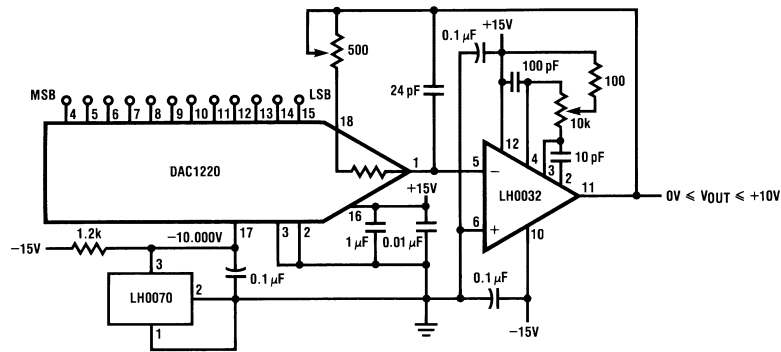

FIGURE 5. Fast Settling DAC

AN007313-5

### Buffered Amplifier

Whenever higher output current is required, a buffer amplifier may be added to the loop as shown in Figure 6. The LH0033 boosts the output drive capability to  $\pm 100$  mA continuous and  $\pm 400$  mA peak.

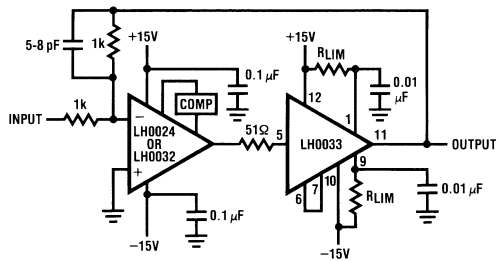

FIGURE 6. Wide Band Amplifier with 100 mA Output Capability

AN007313-6

Despite its 100 MHz bandwidth, the LH0033 introduces about 15 degrees of phase lag at the LH0032 unity-gain frequency of 70 MHz. As a result, phase margin is degraded by the same amount. Slight overcompensation may be required in order to restore adequate phase margin. One way is to increase the feedback capacitor from 5 pF to a slightly larger value, 6 to 8 pF should be sufficient. If the load is predominantly capacitive, the total phase shift of the buffer stage may exceed  $180^\circ$  and appear as negative impedance seen looking into the input of the buffer. The 51Ω resistor restores some real resistance to alleviate this condition and prevents

potential oscillation. In cases where the load capacitance is relatively large, up to 100Ω may be necessary to compensate for it.

### DESIGN CONSIDERATIONS

#### Optimizing LH0024/32 Performance

The LH0024 and LH0032 allow considerable flexibility in designing high performance circuits if care is taken in the way they are used and implemented. Indeed, the printed circuit board layout in high frequency circuits is as important as the design of the hybrid devices themselves.

It is good practice to use ground plane PC board design. It provides a low resistance, low inductance path, and reduces stray signal coupling to sensitive circuitry. A double-sided ground plane is usually better and should be considered.

In addition, signal trace connections should be kept as short and wide as possible. Avoid closely-spaced parallel signal traces as signal cross-coupling may occur. Circuit elements should be placed close to the amplifier, particularly critical components that directly affect the amplifier's frequency response, such as compensation capacitors. If at all possible, one should maintain single point ground throughout the circuit to minimize signal phase delay.

Examples of single-sided PC layouts for the LH0024 and LH0032 are shown in Figure 7 and Figure 8, respectively. The layouts include a settling time test circuit, optional inverting or noninverting mode. Note that the summing junction side of the feedback resistor is kept very close to the device pin, thus minimizing lead capacitance. The power supply decoupling capacitors should also be kept close to the device pins, preferably  $\frac{3}{8}$  of an inch.

#### Input Guarding and Bootstrapping

In applications where input leakage currents are important, such as trace guarding used in sample and hold circuits, can improve performance at no additional cost.

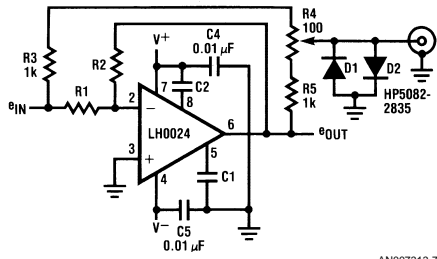

AN007313-7

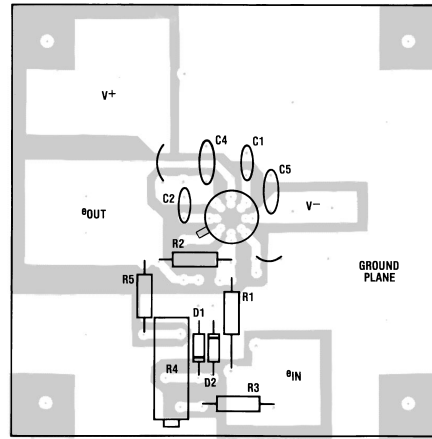

AN007313-8

FIGURE 7. Single-Sided Sample PC Layout for LH0024

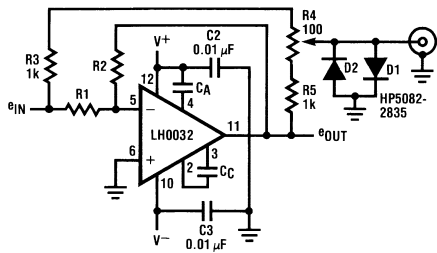

AN007313-9

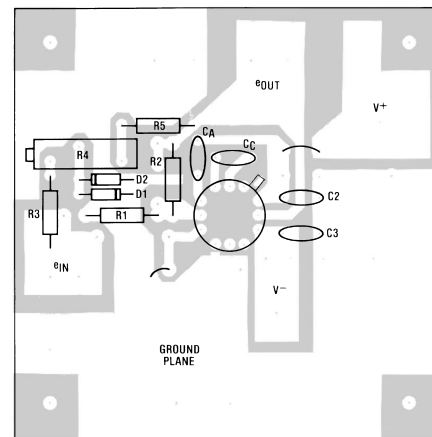

AN007313-12

FIGURE 8. Single-Sided Sample PC Layout for LH0032

The guard conductor serves to intercept leakage currents from inputs to the surrounding circuit. It is most effective when it is driven to the same potential as the guarded circuit. *Figure 9* and *Figure 10* show how the technique is implemented in inverting and non-inverting configurations, respectively.

One other benefit of input guarding is the reduction of input stray capacitance effects. A comprehensive discussion of this technique is described in Application Note AN-63.

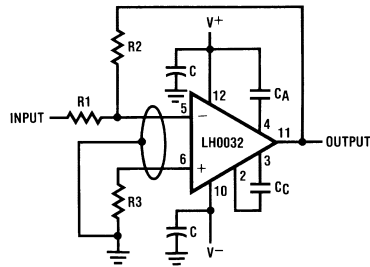

AN007313-10

FIGURE 9. Guarding Inverting Figure Amplifier

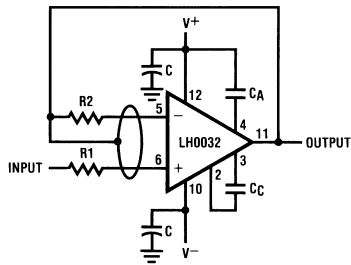

AN007313-11

FIGURE 10. Guarding Non-Inverting Unity Gain Amplifier

#### Input Capacitance Cancellation

The intrinsic input capacitance of the amplifier cannot be totally eliminated by the input guarding technique. This input capacitance introduces a pole in the amplifier response at the frequency given by:

$$f_p = \frac{1}{2\pi R_S C_{IN}} \quad (3)$$

This pole may become extremely important as, for example, a  $C_{IN}$  of 5 pF (typical input capacitance of the LH0024 and LH0032) with a 500Ω effective source resistance creates a pole at about 64 MHz—well before the amplifier's natural frequency response rolls off to unity gain at 70 MHz. If closed-loop gain is unity, more than 135° total phase lag is introduced even before the crossover frequency is reached and will destroy phase margin. Oscillation is certain to occur. The solution is to cancel its effect. As shown in Figure 11, the lead capacitor C1 across the feedback resistor is used to introduce a zero in the loop response such that it exactly cancels the pole caused by the input RC network.

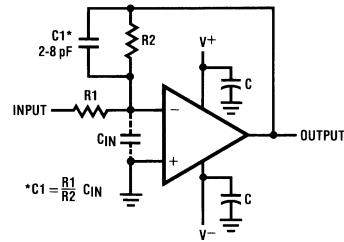

AN007313-13

FIGURE 11. Compensating Amplifier Input Capacitance

Ideally, the ratio of input capacitance  $C_{IN}$  to lead capacitor C1 should equal the closed-loop gain of the amplifier. Under this condition, exact pole-zero cancellation is realized.

Note that Equation (3) dictates the use of source resistance values less than 1 kΩ in circuits operating at or near unity gain to keep  $f_p$  greater than 70 MHz.

#### Frequency Compensation

High-performance wideband op amps such as the LH0024 and LH0032 require external frequency compensation, depending on the closed-loop gain. Optimum AC performance will be affected by a given circuit and its layout. Several compensation techniques are recommended and the best should be selected according to the particular application. Each is discussed in the following sections.

#### Compensating the LH0024

Table 2 provides a guide to compensate the LH0024 at several values of closed-loop gain. Figure 12 shows the basic scheme.

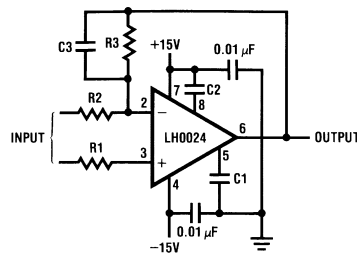

AN007313-14

FIGURE 12. LH0024 Frequency Compensation Circuit

When operating with closed-loop gain of -1, C3 is required and may need slight adjustment to completely cancel the input capacitance of the device, typically 5 pF.

TABLE 2.

Closed-Loop Gain	C1	C2	C3
100	0	0	0
20	0	0	0
10	0	20 pF	1 pF
1	30 pF	30 pF	5 pF

An alternate technique for compensation at a closed-loop gain of 1 is to use an input RC lag compensation network as shown in Figure 13.

With 1 kΩ resistor values in the circuit, R<sub>C</sub> and C<sub>C</sub> should be 82Ω and 0.047 μF, respectively. The difficulty in using this compensation is its involved calculation and experimenting required in order to find the optimum R<sub>C</sub> and C<sub>C</sub> values if resistors other than 1 kΩ are used when the above R<sub>C</sub> and C<sub>C</sub> values are no longer valid and must be redetermined. For this reason, optimum compensation is almost always determined empirically, as were the values given.

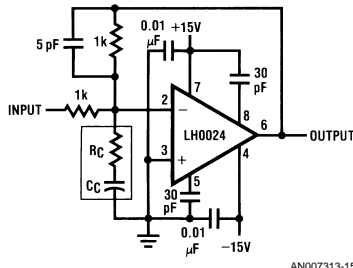

FIGURE 13. Input RC Lag Compensation Circuit

#### Compensating the LH0032

With the LH0032, two compensation schemes may be used, depending on the designer's specific needs.

The first technique is shown in Figure 14. It offers the best 0.1% settling time for a ±10V square wave input. The compensation capacitors C<sub>C</sub> and C<sub>A</sub> should be selected from Figure 15 for various closed-loop gains. Figure 16 shows how the LH0032 frequency response is modified for different value compensation capacitors.

Although this approach offers the shortest settling time, the falling edge exhibits overshoot up to 30% lasting 200 to 300 ns. Figure 17 shows the typical pulse response.

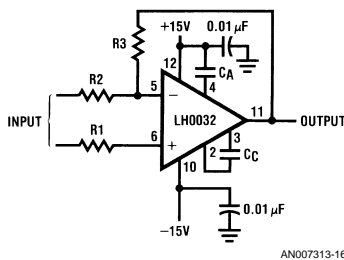

FIGURE 14. LH0032 Frequency Compensation Circuit

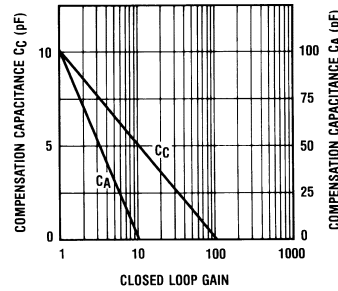

FIGURE 15. Recommended Value of Compensation Capacitor vs. Closed-Loop Gain for Optimum Settling Time

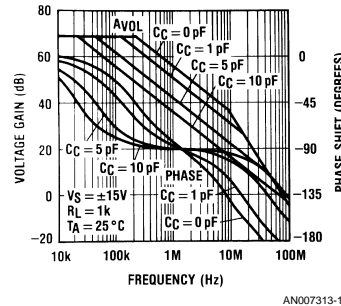

FIGURE 16. The Effect of Various Compensation Capacitors on LH0032 Open Loop Frequency Response

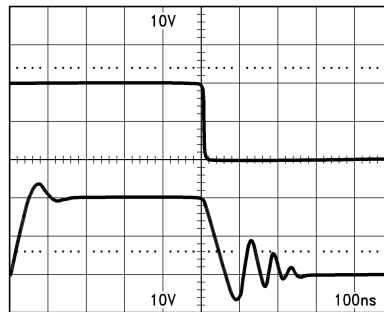
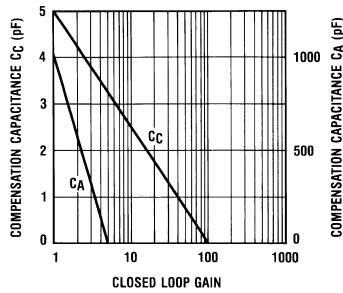
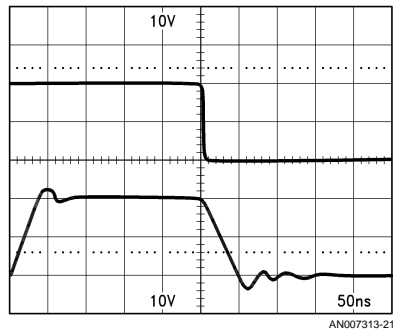

FIGURE 17. LH0032 Unity Gain Non-Inverting Large Signal Pulse Response: T<sub>A</sub> = 25°C, C<sub>C</sub> = 10 pF, C<sub>A</sub> = 100 pF



**FIGURE 18. Recommended Value of Compensation Capacitor vs. Closed-Loop Gain for Optimum Slew Rate**



**FIGURE 19. LH0032 Unity Gain Non-Inverting Large Signal Pulse Response:  $C_C = 5 \text{ pF}$ ,  $C_A = 1000 \text{ pF}$**

If obtaining minimum ringing at the falling edge is the primary objective, a slight modification to the above is recommended. It is based on the same circuit as that of Figure 14. The values of the unity gain compensation capacitors  $C_C$  and  $C_A$  should be modified to 5 pF and 1000 pF, respectively. Figure 18 shows the suitable capacitance to use for various closed-loop gains. The resulting unity gain pulse response waveform is shown in Figure 19. The settling time to 1% final value is actually superior to the first method of compensation. However, the LH0032 suffers slow settling thereafter to 0.1% accuracy at the falling edge, and nearly four times as much at the rising edge, compared to the previous scheme. Note, however, that the falling edge ringing is considerably reduced. Furthermore, the slew rate is consistently superior using this compensation because of the smaller value of Miller capacitance  $C_C$  required. Typical improvement is as much as 50%. A more detailed discussion of this effect is provided in the Slew Response section of this Application Note.

The second compensation scheme works well with both inverting or non-inverting modes. Figure 20 shows the circuit schematic, in which a 270Ω resistor and a 0.01 μF capacitor are shunted across the inputs of the device. This lag compensation introduces a zero in the loop modifying the response such that adequate phase margin is preserved at unity gain crossover frequency. Note that the circuit requires no additional compensation.

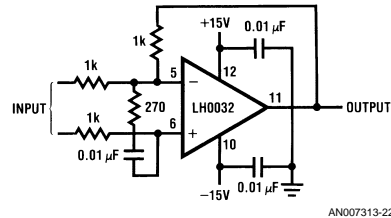
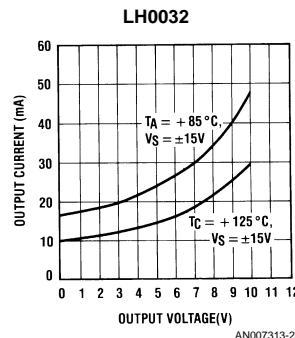
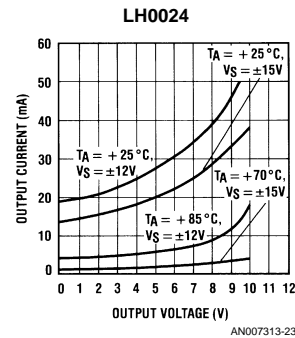

**FIGURE 20. LH0032 Non-Compensated Unity Gain Compensation**

### Output Drive Capability

The LH0024 and LH0032 op amps are designed to deliver, but not to exceed, ±100 mA peak output current for durations under 1 μs at duty cycles under 1%.

The output drive capability of these op amps is limited primarily by device power dissipation. Figure 21 shows the maximum drive capabilities under various conditions. These limits should be observed. Furthermore, the open loop gain decreases slightly as a result of increased output loading. For this reason, continuous output current should be kept under 50 mA.



**FIGURE 21. Continuous Output Drive Capability**

### Capacitive Load Compensation

Capacitive loads cause increased phase shifts in such a way that phase margin decreases toward an unstable state and oscillating may result. The cure is to overcompensate the op amp and to isolate the load with a series resistor (100 to 200Ω) as shown in *Figure 22*. For example, an unterminated coaxial cable presents a capacitive load. Slight overcompensation may be required to maintain stability.

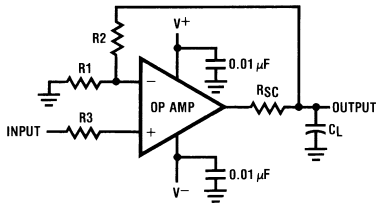

**FIGURE 22. Output Protection when Driving Capacitive Load**

### Power Dissipation

A simple design rule that is often bent, if not broken, is that relating to power dissipation. The limits for the LH0024 and LH0032 are shown in *Figure 23*. Under no circumstances should these guidelines be exceeded within the temperature range specified. The total power dissipation can be easily calculated from the following equation:

$$P_{\text{Total}} = P_Q + P_{\text{Out}} \quad (4)$$

Where:  $P_Q$  = the quiescent power at a given supply voltage and current as specified by the data sheet, and,  
 $P_{\text{Out}}$  = the drive power dissipated in the device output stage, computed as the net rms collector-emitter voltage of the output transistor times the load current.

Determining power dissipation when driving a capacitive load is more involved. The peak power required to charge or discharge the load capacitor is:

$$P_{\text{Peak}} = \frac{C_L (\Delta V)^2}{t} \quad (5)$$

Where:  $\Delta V$  = the change in voltage across  $C_L$ .

$t$  =  $I_{\text{Peak}}$  charging time into  $C_L$ .

Over a full charge and discharge cycle, the power is directly proportional to the frequency of the input pulse waveform. As the pulse repetition frequency increases, so does power dissipation.

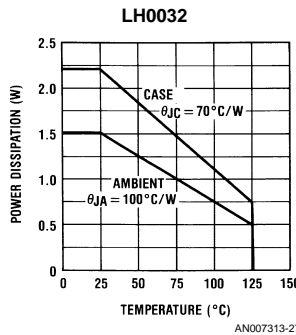
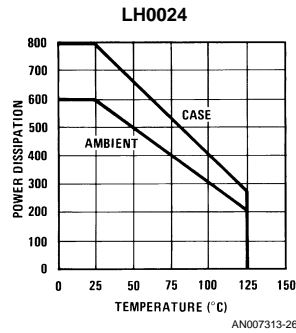

**FIGURE 23. Maximum Power Dissipation**

### Short Circuit Protection

Since the LH0024 and LH0032 have no internal short circuit protection, their relatively high drive capability can sustain current levels sufficient to destroy the devices if high frequency oscillation is induced. This can occur with a large capacitance load. To design in protection, a current limiting resistor  $R_{sc}$  should be inserted at the output of the amplifier inside the feedback loop as shown in *Figure 22*. The value of  $R_{sc}$  can be determined from the following equation:

$$R_{sc} = \frac{V^+}{I_{sc}} \quad (6)$$

Where:  $V^+$  is the power supply voltage.

### Heat Sinking Considerations

Under severe environmental and electrical operating conditions, a low thermal resistance heat sink should be used to assure safe operation. The following is a list of heat sinks from various sources recommended for the TO-8 case style:

- Thermalloy 2240A, 33°C/W
- Wakefield 215CB, 30°C/W
- IERC, UP-TO 8-48CB, 15°C/W

Heat sinks for the TO-5 case style are readily available from many manufacturers. A reasonably priced clip-on unit from Thermalloy, Model 2228B, offers modest thermal resistance of 35°C/W.

### Case Grounding

Grounding the case of the device offers improved immunity from circuit cross-talk, but it compromises additional stray capacitance to every device pin (usually 1–2 pF). In the rare situation where case grounding is required, slight recompensation may be necessary. However, most applications are not demanding enough to warrant its use.

There are several ways to strap, or ground the case. For the LH0032, the best approach is to solder a small metal washer or a small piece of wire between the base of the device metal can and the base of an unassigned lead post. Dedicating pin 7 of the LH0032 for this purpose is recommended, although any other “no connection” pin is acceptable. High temperature solder should be used to avoid solder reflow during normal assembly operations.

The LH0024 has no unused pins available, and thus is not readily adaptable to case strapping. An alternative approach is to use an electrically conductive heatsink with a PC board-mountable option, such as Thermalloy type 2230C-5.

In all uses of case grounding, be on the lookout for ground-induced noise into the signal path. In short, be sure the ground is a *quiet* ground.

### Power Supply Bypass

Power supply pins must be bypassed in all cases to prevent oscillation. A 0.01  $\mu$ F to 0.1  $\mu$ F disc or monolithic ceramic capacitor at each supply pin to ground is adequate. The capacitors should be placed no more than 1/2 inch from the device pins.

### Adjustment of Offset Voltages

When required, the offset voltage of the operational amplifiers may be nulled using a balance potentiometer as shown in *Figure 24*. The 100 $\Omega$  series resistors prevent any adverse oscillation or malfunction when the pot is shorted to either end of the adjustment range.

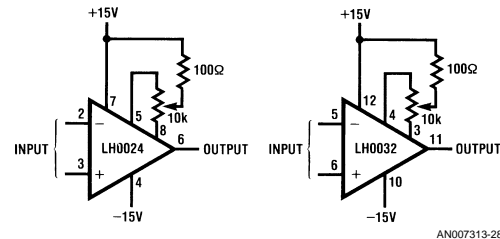

FIGURE 24. Offset Voltage Adjustment

### Slew Response Improvement

Slew rate is the internally limited maximum rate of rise, or fall, at maximum amplifier output swing when driven by a large signal step input. It is primarily limited by the operating current of the input stage. When overdriven by a step function, the input stage operating current charges or discharges the effective circuit capacitance of the second stage. The rate of charge is:

$$\frac{dV}{dt} = \frac{I_{\text{Input Stage}}}{C_{\text{Node}}} \quad (7)$$

In the case of the LH0032, where Miller Compensation is used, the external capacitance adds to the internal circuit capacitance, resulting in reduced slew rate. *Figure 25* illustrates this effect as a function of the capacitance value.

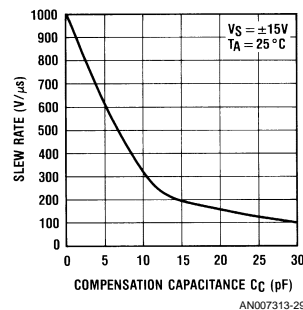

FIGURE 25. LH0032 Slew Rate vs. Frequency Compensation Capacitance

*Figures 26, 27, 28* demonstrate the rising and falling slew capabilities of the LH0024 and LH0032. Notice the improved slew rate performance of the LH0032 using the alternative

compensation technique in *Figure 28* compared to *Figure 27*. The difference is due to the smaller Miller capacitance used in the former.

The LH0024 does not use Miller Compensation, so slew rate is not compromised. Consequently, large signal frequency response is significantly higher than that of the LH0032.

Finally, power supply voltage affects slew rate. As the voltage decreases, input stage operating current decreases accordingly. The net effect is a reduction in the slew rate as the available charging current drops off. *Figure 29* shows the typical slew response of each op amp as a function of supply voltage.

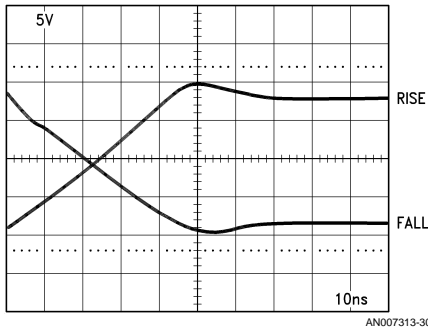

**FIGURE 26. LH0024 Slew Response, Unity Gain Inverting Mode**

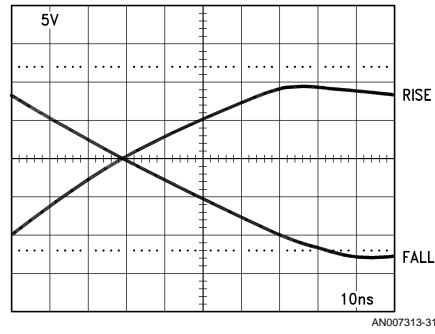

**FIGURE 27. LH0032 Slew Response, Unity Gain Inverting Mode, Standard Compensation ( $C_C = 10 \text{ pF}$ ,  $C_A = 100 \text{ pF}$ )**

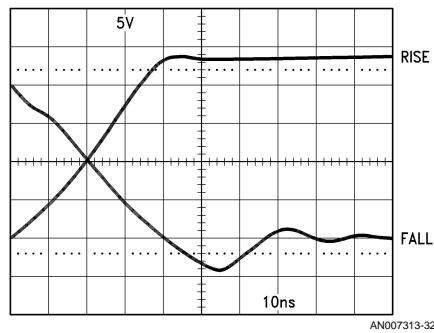

**FIGURE 28. LH0032 Slew Response, Unity Gain Inverting Mode, Improved Compensation ( $C_C = 5 \text{ pF}$ ,  $C_A = 1000 \text{ pF}$ )**

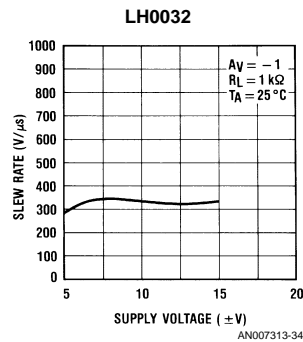
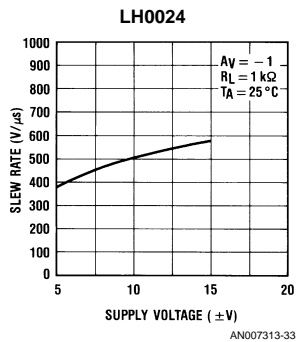

**FIGURE 29. Slew Rate Response as a Function of Supply Voltages**

### Settling Time

Settling time is the time between the start of a step input to the time it takes the output to settle to within a specified error band of the final voltage. This parameter is heavily influenced by the frequency compensation of the amplifier (degree of damping). Undercompensation results in excessive phase shift, overshoot and ringing, and therefore, a long settling time. Equally poor performance results from overcompensation, which yields an overdamped system, slow decay and, again, a long settling time.

Expectedly, settling time is affected by the loop gain of the amplifier. *Figure 30* illustrates this effect for these two devices.

One of the most demanding applications is driving a capacitive load in a circuit such as a high speed sample-and-hold, where accuracy and fast settling time are both important. Because of the additional phase shift introduced by driving the sampling capacitor, the LH0032 must be recomensated. *Figure 31* presents the optimum compensation to obtain fastest settling time under these conditions.

### CONCLUSION

At first glance, the LH0024 and LH0032 seem harmless enough. A more in-depth look reveals the challenges in applying these high performance op amps. The ultimate capa-

bilities that can be extracted are a direct function of careful engineering. With prudence, these devices are harmless indeed.

Application of these high performance amplifiers requires an understanding of compensation and layout technique. With the information presented in this note, the designer should be able to enjoy the benefits of their superior capabilities.

### REFERENCES

1. National Semiconductor *Special Functions Databook*.
2. R. K. Underwood, "New Design Techniques for FET Op Amps" National Semiconductor AN-63, March 1972.
3. J. Wong, J. Sherwin, "Applications of Wide-Band Buffer Amplifiers" National Semiconductor AN-227, October 1979.
4. "LH0082 Optical Communication Receiver" Data Sheet, National Semiconductor Corp.
5. E. Miller, "Introduction to Practical Fiber Optics" National Semiconductor AN-244, May 1980.

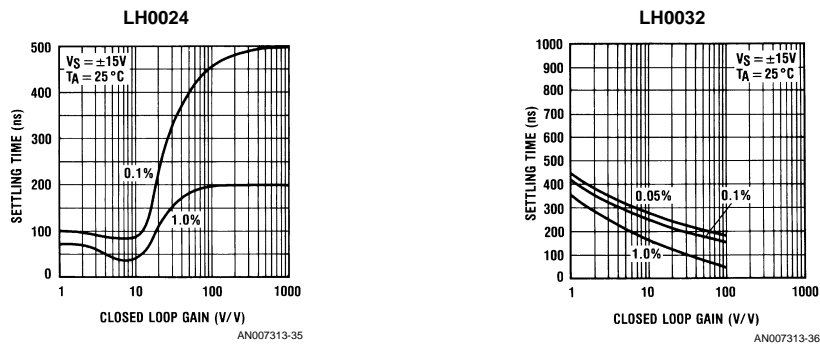

FIGURE 30. Settling Time vs. Closed-Loop Gain

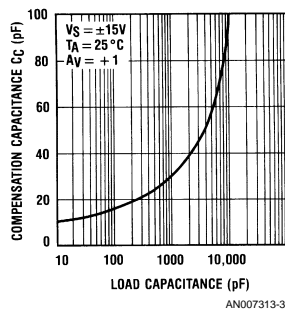
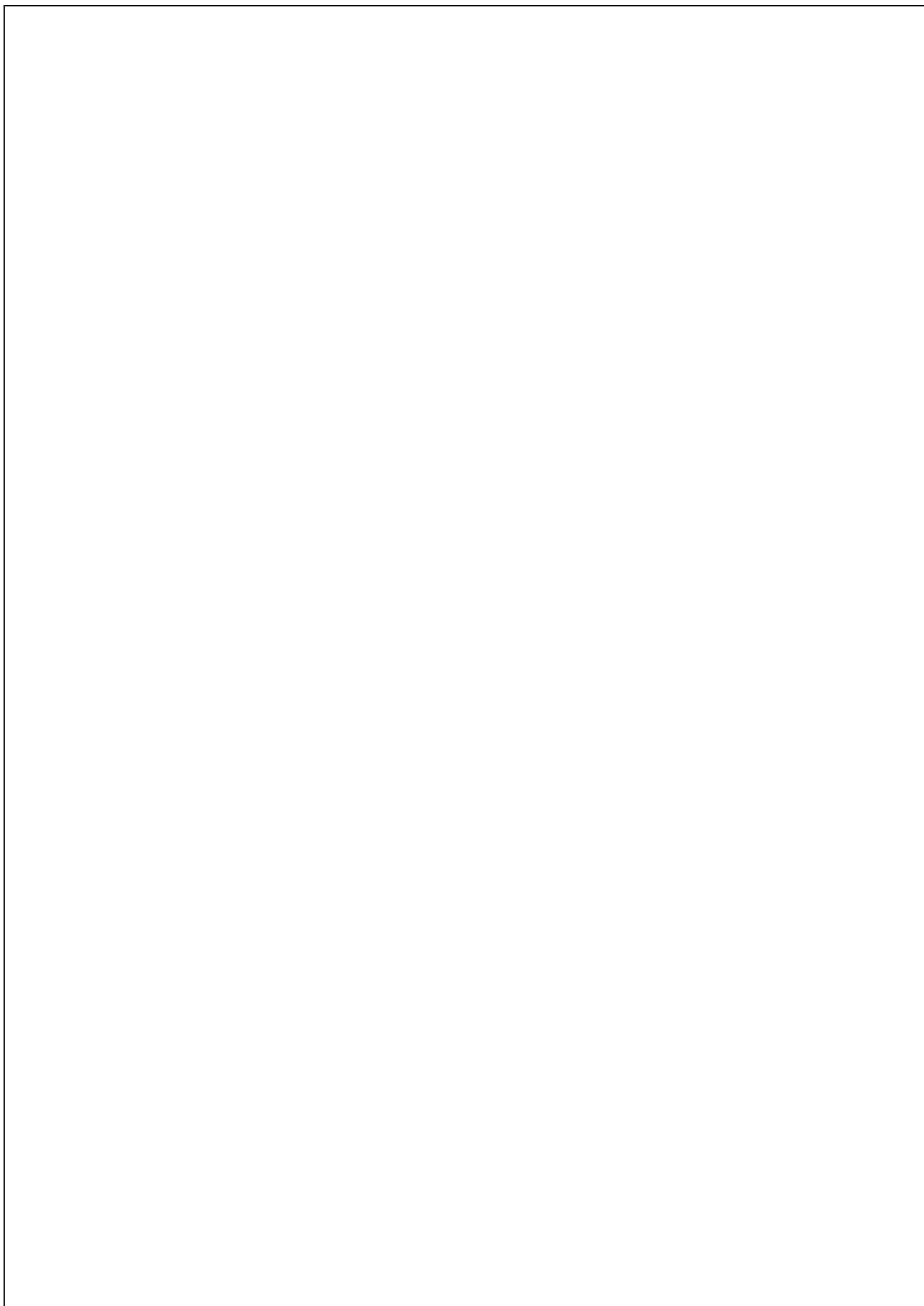

FIGURE 31. Frequency Compensation vs. Load Capacitance



**LIFE SUPPORT POLICY**

NATIONAL'S PRODUCTS ARE NOT AUTHORIZED FOR USE AS CRITICAL COMPONENTS IN LIFE SUPPORT DEVICES OR SYSTEMS WITHOUT THE EXPRESS WRITTEN APPROVAL OF THE PRESIDENT OF NATIONAL SEMICONDUCTOR CORPORATION. As used herein:

1. Life support devices or systems are devices or systems which, (a) are intended for surgical implant into the body, or (b) support or sustain life, and whose failure to perform when properly used in accordance with instructions for use provided in the labeling, can be reasonably expected to result in a significant injury to the user.
2. A critical component in any component of a life support device or system whose failure to perform can be reasonably expected to cause the failure of the life support device or system, or to affect its safety or effectiveness.

 <p><b>National Semiconductor Corporation</b> Americas Tel: 1-800-272-9959 Fax: 1-800-737-7018 Email: support@nsc.com</p>	<p><b>National Semiconductor Europe</b> Fax: +49 (0) 1 80-530 85 86 Email: europe.support@nsc.com Deutsch Tel: +49 (0) 1 80-530 85 85 English Tel: +49 (0) 1 80-532 78 32 Français Tel: +49 (0) 1 80-532 93 58 Italiano Tel: +49 (0) 1 80-534 16 80</p>	<p><b>National Semiconductor Asia Pacific Customer Response Group</b> Tel: 65-2544466 Fax: 65-2504466 Email: sea.support@nsc.com</p>	<p><b>National Semiconductor Japan Ltd.</b> Tel: 81-3-5620-6175 Fax: 81-3-5620-6179</p>
--	---	--	---

www.national.com

National does not assume any responsibility for use of any circuitry described, no circuit patent licenses are implied and National reserves the right at any time without notice to change said circuitry and specifications.